

AS2 MIKROS

EN Use and Maintenance

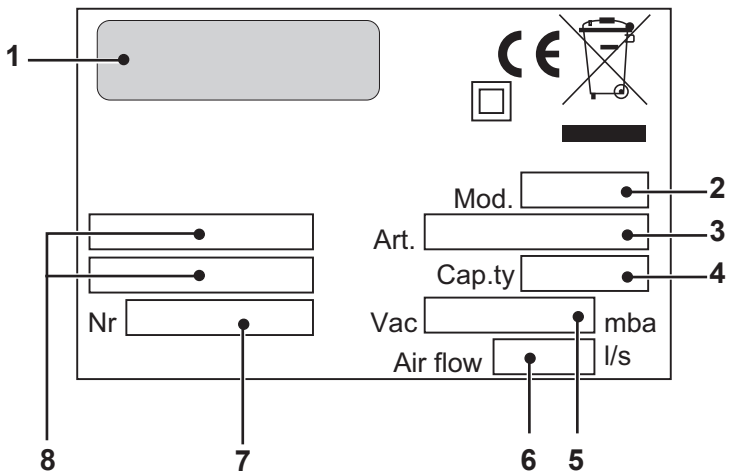

80 50 826
ed. 10-2018

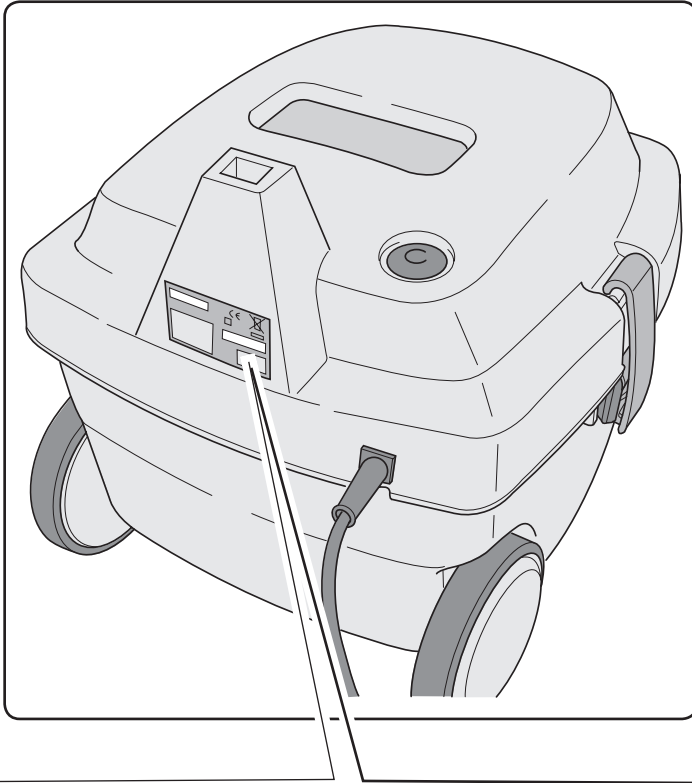

	1	2	3	4	5	6	7	8
IT	Produttore	Modello	Articolo	Capacità fusto	Capacità aspirazione	Portata d'aria	N° Matricola	Caratteristiche elettriche
EN	Manufacturer	Model	Article	Container capacity	Vacuum	Air flow	Serial N°	Electrical characteristics
FR	Producteur	Modèle	Article	Capacité de la cuve	Capacité d'aspiration	Débit d'air	N° Matricule	Caractéristiques électriques
DE	Hersteller	Modell	Artikel	Fassungsvermögen des Körpers	Ansaugleistung	Luftdurchsatz	Matrikelnr.	Elektrische Eigenschaften
ES	Fabricante	Modelo	Artículo	Capacidad del bidón	Capacidad de aspiración	Caudal de aire	N° Matricola	Características eléctricas
PT	Produtor	Modelo	Artigo	Capacidade do reservatório	Capacidade de aspiração	Caudal de ar	Número de série	Características eléctricas
NL	Producent	Model	Artikel	Inhoud reservoir	Zuigcapaciteit	Luchtdebiet	Serienummer	Elektrische eigenschappen
NO	Produsent	Modell	Artikkel	Beholderkapasitet	Sugekapasitet	Lufmengde	Matrikelnr.	Elektriske egenskaper
DK	Fabrikant	Model	Artikel	Beholdervolumen	Sugeeffekt	Luftmængde	Matrikelnummer	El-specifikationer
SV	Tillverkare	Modell	Artikel	Korgens kapacitet	Sugkapacitet	Luftflöde	Serienummer	Elektriska egenskaper
PL	Producent	Model	Artykuł	Pojemność zbiornika	Podciśnienie (mbar)	Przepływ powietrza	Nr. Fabryczny	Właściwości elektryczne
CS	Výrobce	Model	Typ	Obsah nádoby	Sací výkon	Množství dopravovaného vzduchu	Výrobní č.	Elektrické údaje
SK	Výrobca	Model	Výrobok	Objem nádoby	Sací výkon	Prítok vzduchu	Výrobné č.	Elektrické vlastnosti
TR	Üretici	Model	Ürün	Gövde kapasitesi	Aspirasyon kapasitesi	Hava Akışı	Seri No	Elektriksel Özellikler
HU	Gyártó	Modell	Cikk	A szár teljesítménye	Szívó teljesítmény	Levegőhozam	Törzskönyvi szám	Elektromos sajátosságok
RO	Producător	Model	Articol	Capacitate rezervor	Capacitate aspiratie	Volum aer	Nr. Matricol	Caracteristici electrice
EL	Κατασκευαστής	Μοντέλο	Προϊόν	Χωρητικότητα κάδου	Ικανότητα αναρρόφησης	Ροή αέρα	Αρ. Μητρώου	Ηλεκτρικά χαρακτηριστικά
RU	Изготовитель	Модель	Артикул	Емкость бака	Мощность всасывания	Расход воздуха	Заводской №	Электрические характеристики
HR	Proizvođač	Model	Proizvod	Zapremnina spremnika	Usisni kapacitet	Protok zraka	Registracijski br.	Električna svojstva
SR	Proizvođač	Model	Proizvod	Kapacitet posolja	Kapacitet usisa	Nosivost vazduha	Br° Proizvoda	Električne karakteristike

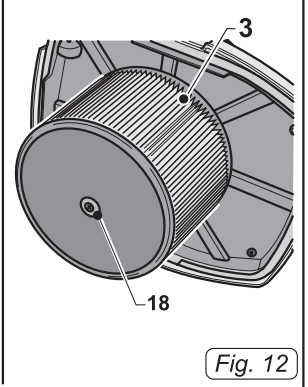
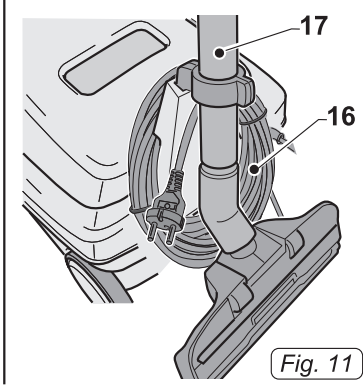
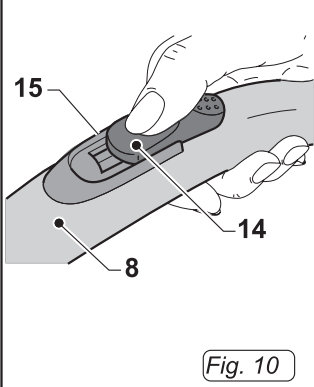
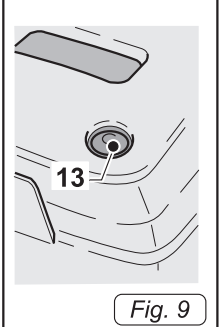
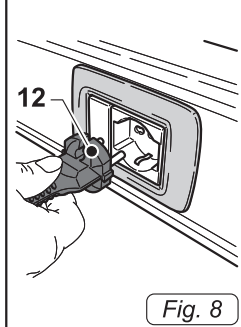
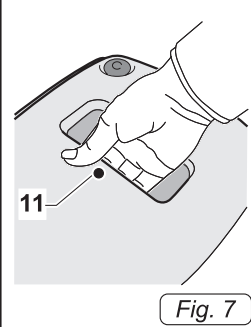
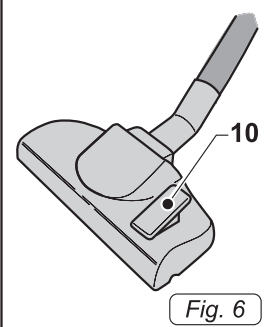
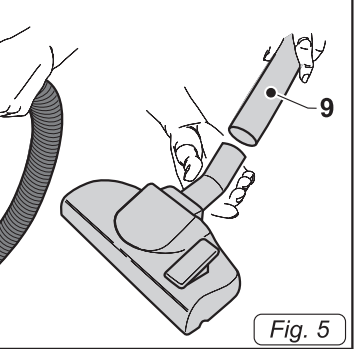
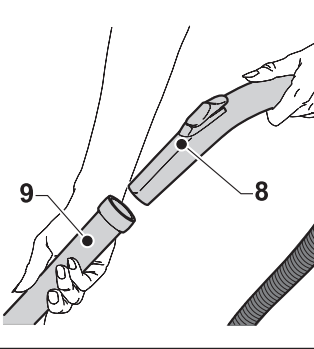
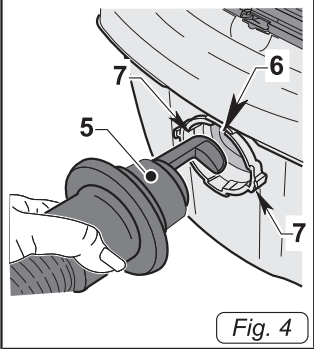
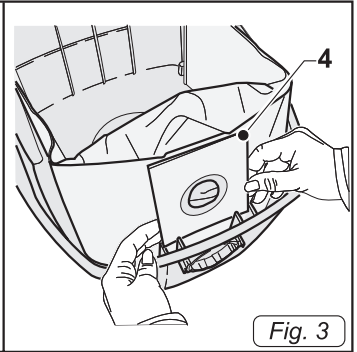
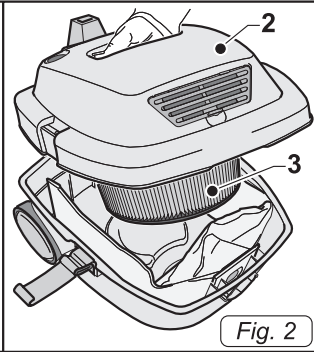
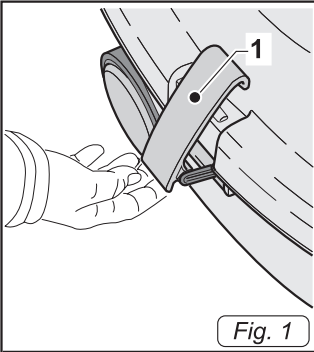

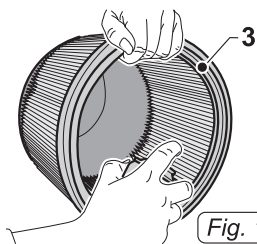

Fig. 13

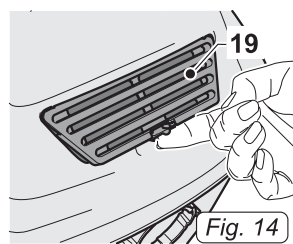

Fig. 14

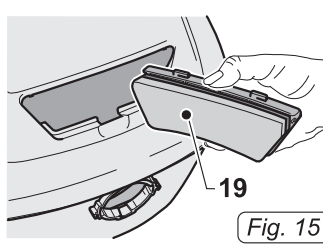

Fig. 15

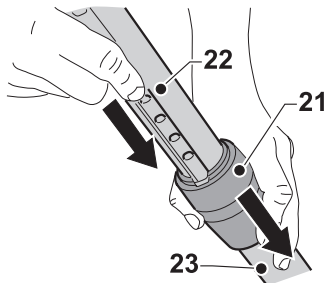
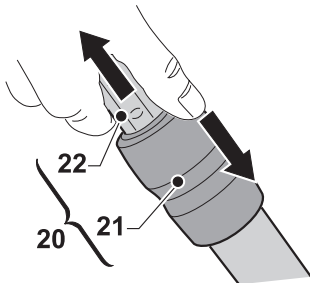

Fig. 16



English ENGLISH - 1
(Translation of original instructions)

TECHNICAL FEATURES

Tension.....	See data plate
Motor power	800 W
Noise level.....	62 dB(A)
Depression.....	210 mmH ₂ O
Paper bag capacity	12 l
Dimensions	390 x 340 x 290H mm
Weight	4.6 kg
Accessories.....	Ø 32 mm

TYPE OF USE

This unit must solely be used to vacuum dust, crumbs, etc. as it is designed solely for this purpose.



HAZARD:

The manufacturer cannot be held liable for any damage caused by improper or incorrect use.

Any other use relieves the Manufacturer from all responsibility of damage caused to persons and/or things and renders the warranty null and void.

INCORRECT USE

Do not use the unit to:

- vacuum any type of liquid;
- vacuum flammable, explosive, corrosive and toxic substances.
- vacuum hot substances.

Do not use the unit in explosive atmospheres.

PREPARING THE UNIT

Checking the filter systems

- Release the levers (1 Fig.1) and remove the cover (2 Fig.2) complete with the motor unit and cartridge filter (3 Fig.2).
- Check that the paper filter bag (4 Fig.3) is in place inside the device.

- If the paper filter bag (4 Fig.3) is not present, insert it by putting the square cardboard stiffener into the slot in the drum.
- Replace the cover and lock it using the levers (1 Fig.1).

Assembling the pipes

- Insert the sleeve with bayonet connection (5 Fig.4) into the hole (6 Fig.4) in the container, aligning the connections present in the sleeve with the slots (7 Fig.4) in the hole in the container, then rotate the sleeve clockwise to lock it.
- Hook the rigid extensions (8 Fig.5) to the ergonomic handle (9 Fig.5) of the flexible pipe.
- Attach the desired accessory (floor tool, dusting brush, crevice tool, multi-purpose brush etc.) to the suction tube (9 Fig.5)

Using the telescopic tube

- The length of the telescopic tube (20 Fig. 16) can be adjusted as follows:
- To lengthen the tube, press down on the ring nut (21 Fig. 16) and simultaneously extract the top part (22 Fig. 16) of the tube. Once the required length has been obtained, release the ring nut (21 Fig. 16) the tube will lock into the nearest locking position;
- To shorten the telescopic tube, use one hand to push the ring nut (21 Fig. 16) down and the other to reinsert the top tube (22 Fig. 16) into the lower sleeve (23 Fig. 16).

Multi-purpose brush

The multi-purpose brush should be used as follows:

- To clean hard floors, parquet etc. press the lever back (10 Fig.6) to remove the bristles from the brush.
- To vacuum on carpets, rugs etc. press the lever forward (10 Fig.6) to retract the brush bristles.

USING THE UNIT

- The appliance is fitted with wheels and can therefore be pulled along during use using the hose.
- To lift it up, use the handle (11 Fig.7) on the top of the cover. Starting up the appliance

Starting-up the unit

- Insert the plug (12 Fig.8) into the socket.
- Press the switch (13 Fig.9). The appliance starts up.



NOTE:

You can adjust the suction force by sliding the selector (14 Fig.10) found on the ergonomic handle (8 Fig.10).

The suction force is decreased by opening the window (15 Fig.10)

Turning the unit off

- Press the switch (13 Fig.9) to switch off the appliance.
- Remove the plug (12 Fig.8) from the socket.
- Wind up the cable (16 Fig.11) and hook it into position then attach the suction tube (17 Fig.11) in position

CLEANING AND MAINTENANCE



HAZARD:

The plug must be removed from the socket before any maintenance procedure is implemented.

Removing and replacing the paper filter bag

- Release the levers (1 Fig.1) and remove the cover (2 Fig.2) complete with the motor and the cartridge filter (3 Fig.2).
- Remove the paper filter bag (4 Fig.3) and replace as indicated above.
- Reassemble everything proceeding in reverse order.

Checking and cleaning the filter cartridge

- Release the levers (1 Fig.1) and remove the cover (2 Fig.2) complete with the motor cartridge filter (3 Fig.2).
- Unscrew the central screw (18 Fig.12) and remove the cartridge filter (3 Fig.12).
- Clean the filter (3 Fig.13) from the inside out with a jet of air. If this is too dirty, it must be changed.
- Remount all the parts by following the reverse procedure of the dismantling process.

Checking the exhaust air filter

- Release the filter (19 Fig.14) and remove it from the appliance.
- Make sure the filter is not clogged. If it is too dirty, replace it.
- Remount all the parts by following the reverse procedure of the dismantling process.

Cleaning the unit body

- Clean the unit body with a cloth dampened with water or a neutral detergent.



HAZARD:

Do not wash the unit with jets of water.

SPARE PARTS

Pack 5 paper filter bags	Code MK-042
Cartridge filter	Code MK-016
HEPA Filter	Code MK-041

PROBLEM	CAUSE	REMEDY
Vacuum cleaner does not work.	Switch is not pressed. Plug is not inserted. Power cut.	Press the switch. Insert the plug into the socket. Check the power line.
Unsatisfactory suction.	Paper bag is full. Filter components are clogged. Clogged accessories or pipes.	Replace the dust bag. Clean the filter components. Check and clean the flexible pipe and the suction outlet.





DEALER

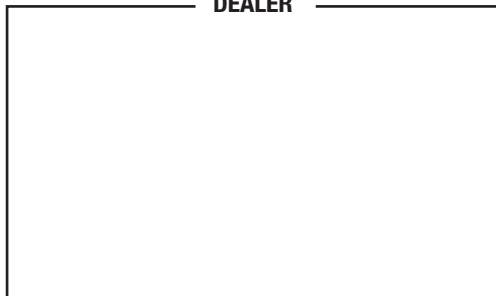

Cod. 8050826 - 2^ ed. - 10/2018

Ghibli & Wirbel S.p.A.

Via Circonvallazione, 5 - 27020 Dorno PV - Italia
P. +39 0382 848811 - F. +39 0382 84668 - M. info@ghibliwirbel.com

www.ghibliwirbel.com

100% MADE IN ITALY

A COMPANY GROUP OF RIELLO INDUSTRIES

